

Statement	1
Summary	2
Safety instructions	2
Safety symbol	2
Safe operation specifications	3
Instrument instructions	6
LCD symbol instructions	8
Measurement instructions	10
AC voltage measurement	11
DC voltage measurement	12
mV gear voltage measurement	13
Resistance/connectivity/diode/capacitance measurement	14
Non-contact electricity verification (NCV) / Live wire detection (Live)	15
Frequency / Duty ratio	17
uA current	17
mA current	18
A current	20
General technical index	21
Accuracy index	22
Instrument maintenance	26
General maintenance	26
Replacement of the battery and fuse tube	27

Statement

According to the Universal Copyright Convention, without permission and written consent, no content of this manual may be reproduced in any form (including storage and retrieval or translation into the languages of other countries or regions). This manual is subject to change in future versions without extra notice.



Caution

The "caution" sign indicates the condition and operation that will cause damage to the instrument or equipment.

It requires that care must be taken when performing this operation. If it is not performed correctly or this operation step is not followed, the instrument or equipment may be damaged. Do not continue to perform any operation indicated by the caution sign unless these conditions are met or fully understood.

Please read the manual carefully and pay attention to the relevant safety warning information before using the instrument.

Summary





This instrument is a compact hand-held 6000 count digital multimeter with high performance and high reliability. It is equipped with overload protection circuit, which can be used to measure AC and DC voltage and current, resistance, diode, circuit connectivity test, non-contact electricity verification and live wire detection. AC voltage is also equipped with VFD low-pass filter, Can be used to measure inverter voltage,filter attenuation-0.94dB@1kHz.

Safety instructions

This instrument is designed and produced in strict accordance with the Safety Standard IEC61010, and meets the safety standard of Overvoltage Standard 600V CAT III and Pollution level 2.

Please use the instrument as this manual, otherwise the protection function provided by the instrument may be reduced or invalid.

Safety symbol

	Please refer to the instructions for important safety information,
	AC high voltage danger
	Non-recyclable
	The fuse must be replaced according to the designated specification in the manual.

Safe operation specifications

Warning

To avoid possible electric shock or physical injury, please comply with the following specifications:

- Before using the instrument, please read the manual carefully and use the instrument in strict accordance with it, otherwise the protection provided by the instrument may be reduced or invalid.
- Check the shell before using the instrument. Check whether there is crack or plastic part defect. Please carefully check the insulator near the input terminal.
- If the instrument works abnormally or is damaged, do not use it.
- It is forbidden to touch live conductors whose voltage exceeds 30V RMS AC, 42 V AC peak or 60V DC.
- The instrument should be used according to the specified measurement category, voltage or current rating.
- When the indication of insufficient battery power is displayed, please replace the battery in time to prevent measurement errors.
- Please comply with local and national safety specifications. Wear personal protective equipment

(approved rubber gloves, masks, flame retardant clothing, etc.) to prevent injury caused by electric shock and arc when dangerous live conductors are exposed.

- Do not use the HOLD function to measure unknown voltage. After HOLD is turned on, the display screen will not change when different voltages are measured.
- Measure a known voltage to determine whether the instrument operates normally.
- When measuring, the correct function and range gear must be used.
- Do not use the instrument around explosive gas and steam or in humid environment.
- Do not use damaged probes. Check whether the insulation of the probe is damaged, whether there is exposed metal or signs of wear. Check the continuity of the probes.
- When measuring, please connect the neutral wire or ground wire first, and then the live wire; when disconnecting, please cut off the live wire first, and then disconnect the neutral wire and ground wire.
- When measuring, please hold your fingers behind the probe finger protector.

- Please disconnect the probe from the measured object before opening the back cover of the instrument.
- Do not use the instrument in an environment that exceeds the measurement category (CAT) rating of the lowest rated single element in the instrument, probe or accessories.

Instrument instructions

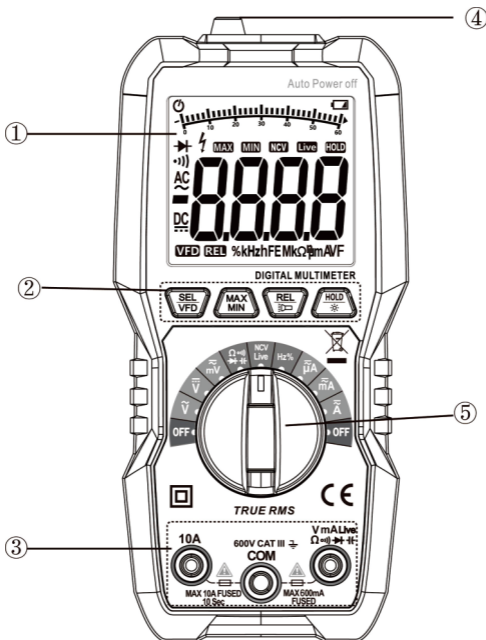

①. LCD display:

It is with 4 digit 7-segment nixie tube display, 6000 counts, and analog bar indication function.

②. Key area:



Function selection key:

Briefly press the key to switch gear function, and long press the key for about 2 seconds to turn on or turn off VFD low-pass filter.

Attention: VFD low-pass filter only works at AC voltage gear (\tilde{V}).



Maximum and minimum value key:

Briefly press the key to start the maximum or minimum value measurement, and long press the key for about 2 seconds to exit the maximum or minimum value measurement.



Relative value measurement / Lighting key:

Briefly press the key to turn on or turn off the relative value measurement, and long press the key for about 2 seconds to turn on or turn off the light.



Data retention / LCD backlight key:

Briefly press the key to turn on or turn off the data retention display, and long press the key for about 2 seconds to turn on or turn off the LCD backlight.

③. Input jack area:

10A jack:

The positive input terminal of 10A current measurement (connected with the red probe).

COM jack:

Common input terminal for voltage, resistance, diode, capacitance, connectivity and current measurement (connected with the black probe).

VmA^{Live}
 Ω \rightarrow \rightarrow \rightarrow jack:

Positive input terminal for voltage, resistance, diode, capacitance, connectivity, live wire detection, current measurement within 600mA (connected with the red probe).

④. NCV sensing area

It is used for non-contact voltage verification.

⑤. Function rotary switch:

It is used to select the measurement function.



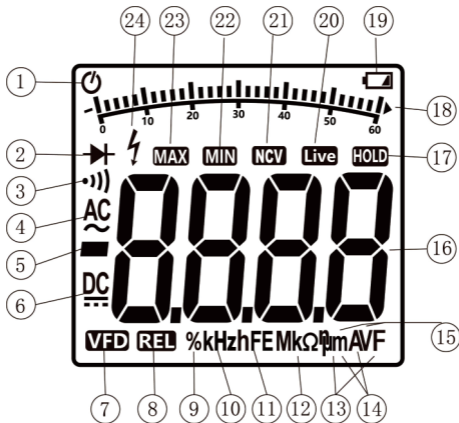

LCD symbol instructions



①	Automatic shutdown indicator	⑬	Capacitance unit
②	Diode measurement indicator	⑭	Current unit
③	Connectivity measurement indicator	⑮	Voltage unit
④	AC indicator	⑯	Data display area
⑤	Data minus indicator	⑰	Display retention key
⑥	DC indicator	⑱	Analog bar indication
⑦	VFD low pass filter indicator	⑲	Battery low voltage indicator
⑧	Relative measurement indicator	⑳	Contact live wire electricity verification indicator
⑨	Positive duty ratio percentage indicator	㉑	Non-contact electricity verification indicator
⑩	Frequency gear	㉒	Minimum value indicator
⑪	Invalid symbol	㉓	Maximum value indicator
⑫	Resistance unit	㉔	AC high voltage indication

Measurement instructions

Precautions before operation:

1. Turn on the power and check whether the battery is under voltage. If "" is displayed on the screen, you need to replace the battery before operation. If not, please follow the steps below.
2. The "" warning symbol next to the jack of the measurement probe indicates that the input voltage or current should not exceed the indicated value, which is to protect the internal circuit of the instrument from damage.
3. The instrument has the function of automatic shutdown, that is, the display shows "" and it will shut down automatically about 10 minutes after no operation. Cancel the automatic shutdown function: press and hold the "" key to start the machine, after hearing the beep sound for about 5 times, release the key, and the "" is not displayed on the display screen, which can prevent the instrument from entering the sleep state during the measurement process.
4. The backlight function turns off automatically after about 15 seconds.
5. The lighting function will turn off automatically about 15 seconds after it is turned on.

AC voltage measurement

1. Insert the red probe into the $\overset{\text{V mA Live}}{\Omega \rightarrow \text{---}}$ jack and the black probe into the **COM** jack.
2. Turn the knob switch to the " $\tilde{\text{V}}$ " position, and connect the probe to the power supply or load to be measured, and the measured value will be displayed on the screen.
3. Press " $\begin{matrix} \text{SEL} \\ \text{VFD} \end{matrix}$ " key to switch frequency and duty ratio, and long press it to turn on or turn off VFD function.

Attention:

1. Before turning the function rotary switch, leave the measurement probe from the circuit under measurement.
2. When the screen only displays "OL", it means that the range has been exceeded and the measurement should be terminated.
3. Do not input AC voltage with effective value higher than 600V, otherwise there is a risk of damaging the instrument.
4. Pay special attention to avoid electric shock when measuring high voltage.

DC voltage measurement



1. Insert the red probe into the "mA Live" jack and the black probe into the **COM** jack.
2. Turn the knob switch to the " \overline{V} " position, and connect the probe to the power supply or load to be measured. The polarity and measured value of the contact terminal of the red probe will be displayed on the screen.



Attention:

1. Before turning the function rotary switch, leave the measurement probe from the circuit under measurement.
2. When the screen only displays "OL", it means that the range has been exceeded and the measurement should be terminated.
3. Do not input AC voltage with effective value higher than 600V, otherwise there is a risk of damaging the instrument.
4. Pay special attention to avoid electric shock when measuring high voltage.



mV gear voltage measurement

1. Insert the red probe into the " Ω  " jack and the black probe into the **COM** jack.
2. Turn the knob switch to the " \approx **mV**" position, and connect the probe to the power supply or load to be measured. The polarity and measured value of the contact terminal of the red probe will be displayed on the screen.
3. Press the  key to switch DC voltage, AC voltage and frequency measurement.

Attention:

1. Before turning the function rotary switch, leave the measurement probe from the circuit under measurement.
2. When the screen only displays "OL", it means that the range has been exceeded and the measurement should be terminated.
3. Do not input AC voltage with effective value higher than 600V, otherwise there is a risk of damaging the instrument.
4. Pay special attention to avoid electric shock when measuring high voltage.

Resistance/connectivity/diode/capacitance measurement





1. Insert the red probe into the " Ω  \rightarrow \leftarrow \leftarrow \leftarrow " jack and the black probe into the **COM** jack.
2. Turn the knob switch to the " Ω  \rightarrow \leftarrow \leftarrow \leftarrow " position and press the  key to switch the measurement of resistance, connectivity, diode and capacitance.
3. Connect the probe to the measured object and read the measurement result from the display.



Attention:

1. Before turning the function rotary switch, leave the measurement probe from the circuit under measurement.
2. When the screen only displays "OL", it means that the range has been exceeded and the measurement should be terminated.
3. Do not input AC voltage with effective value higher than 600V, otherwise there is a risk of damaging the instrument.
4. When measuring large capacitance, discharge the capacitance before measuring.

Non-contact electricity verification (NCV) / Live wire detection (Live)

1. Turn the knob switch to the " ^{NCV}Live " position and press the  key to switch NCV or Live function.
2. Under the NCV function, place the NCV sensing area close to the wire to be measured. When the AC voltage is detected, the buzzer will make an intermittent sound, which varies with the intensity of the induced voltage. Meanwhile, the number of "  " is displayed on the display screen. The more the number, the stronger the induced signal.
3. Under the Live function, insert the red probe into the " ^{VmA^{Live}}Ω →  " jack, and the black probe is not connected. Connect the red probe to the cable to be measured. When the detected electric AC voltage is greater than about 36V, the buzzer will emit intermittent sound, which varies with the intensity of the induced voltage. Meanwhile, the number of "  " is displayed on the display screen. The more the number, the stronger the induced signal.

Note: NCV mode can also connect the probe in Live mode to judge the live wire, but the sensitivity will be higher than that in Live mode.



NCV

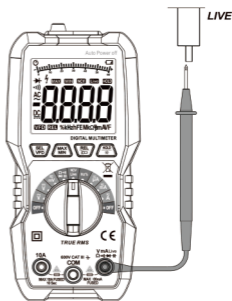



Live

⚠ Warning:

1. Measurement range: about 36V~600V, 50Hz or 60Hz.
2. When using, even if there is no sound or display prompt, the wire to be measured may still have voltage. The instrument may be affected by other factors (such as shielded wires and cables, thickness of insulation layer, distance from voltage source, diversity in socket design, etc.), and fail to sense the electric field.
3. When judging the live wire, do not put your fingers or conductors into the COM jack, otherwise there may be a risk of electric shock.



Frequency / Duty ratio

1. Insert the red probe into the " Ω  " jack and the black probe into the **COM** jack.
2. Turn the knob switch to the "**Hz%**" position and press the  key to switch the frequency or duty ratio.
3. Connect the measurement probe to the load or the measured terminal and read the value from the display screen.

Warning:

1. Before turning the function rotary switch, leave the measurement probe from the circuit under measurement.
2. Do not input a voltage with an effective value higher than 600V, otherwise there is a risk of damaging the instrument.

uA current

1. Insert the red probe into the " Ω  " jack and the black probe into the **COM** jack.
2. Turn the knob switch to the " **μ A**" position and press the  key to switch the AC current, DC current or frequency measurement.

3. Connect the measurement probe in series to the load, and the polarity of the red probe connection will be displayed when the current value is displayed.

 **Warning:**

1. Before turning the function rotary switch, leave the measurement probe from the circuit under measurement.
2. When the screen only displays "OL", it means that the range has been exceeded and a higher gear range should be switched for measurement.
3. Do not input a voltage with an effective value higher than 600V, otherwise there is a risk of damaging the instrument.
4. Do not input a current with an effective value higher than 600uA, otherwise there is a risk of damaging the instrument.

mA current

1. Insert the red probe into the  jack and the black probe into the **COM** jack.

2. Turn the knob switch to the " \tilde{mA} " position and press the  key to switch the AC current, DC current or frequency measurement.
3. Connect the measurement probe in series to the load, and the polarity of the red probe connection will be displayed when the current value is displayed.



Warning:

1. Before turning the function rotary switch, leave the measurement probe from the circuit under measurement.
2. When the screen only displays "OL", it means that the range has been exceeded and a higher gear range should be switched for measurement.
3. Do not input a voltage with an effective value higher than 600V, otherwise there is a risk of damaging the instrument.
4. Do not input a current with an effective value higher than 600uA, otherwise there is a risk of damaging the instrument.

A current

1. Insert the red probe into the "10A" jack and the black probe into the **COM** jack.
2. Turn the knob switch to the " \tilde{A} " position and press the  key to switch the AC current, DC current or frequency measurement.
3. Connect the measurement probe in series to the load, and the polarity of the red probe connection will be displayed when the current value is displayed.



Warning:

1. Before turning the function rotary switch, leave the measurement probe from the circuit under measurement.
2. When the screen only displays "OL", it means that the range has been exceeded and the measurement shall be terminated.
3. Do not input a voltage with an effective value higher than 600V, otherwise there is a risk of damaging the instrument.
4. Do not input a current with an effective value higher than 600uA, otherwise there is a risk of damaging the instrument.

General technical index

- Service environmental conditions:
 - IEC/EN 61010-1 600V CAT III, Pollution level 2。
 - Altitude < 2000m。
 - Temperature and humidity of working environment:
 - 0~40 °C (<80% RH, <10 °C is not considered).
 - Temperature and humidity of storage environment:
 - 10~60 °C (<70% RH, remove the battery).
- Temperature coefficient: 0.1 accuracy / °C.
- The maximum allowable voltage between the measuring terminal and the ground: 600V DC or AC RMS.
- Sampling rate: about 3 times / second
- Automatic shutdown: about 10 minutes.
- 6000 Display: the maximum displayed value is 6000
- Range exceeding indication: "OL" is displayed.
- Battery low voltage indication: when the battery voltage is lower than the normal working voltage, the "" will be displayed on the LCD.
- Input polarity indication: the "-" symbol is automatically displayed.
- Battery: DC 1.5V AAA ×2。
- Overall dimension: 166mm × 78mm × 64mm
- Weight: about 268g

Accuracy index

Accuracy: (reading + digit), warranty period of 1 year.

Reference conditions: the ambient temperature is 18 °C to 28 °C, and the relative humidity is not greater than 80%.

AC voltage

Range	Resolution	Accuracy
60mV	10uV	± (0.8% reading +3 digits)
600mV	100uV	
6V	1mV	
60V	10mV	
600V	100mV	

Maximum allowable measurement voltage: 600V (RMS)

Frequency range: : 40Hz~1000Hz

DC voltage

Range	Resolution	Accuracy
60mV	10uV	± (0.5% reading +3 digits)
600mV	100uV	
6V	1mV	
60V	10mV	
600V	100mV	

600V Maximum allowable measurement voltage: 600V

Resistance

Range	Resolution	Accuracy
600Ω	0.1Ω	±(1.2% reading +5 digits)
6kΩ	1Ω	
60kΩ	10Ω	
600kΩ	100Ω	
6MΩ	1kΩ	
60MΩ	10kΩ	±(2.0% reading +5 digits)

Over voltage protection: 600V DC or AC RMS

Diode and connectivity

Range	Description	Remarks
Diode	Display approximate diode forward voltage value	The circuit voltage is about more than 2V
Connectivity	The conductive resistance is about less than 30 Ω, and the buzzer sounds continuously.	The circuit voltage is less than 1V

Capacitance

Range	Resolution	Accuracy
10nF	0.01nF	±(3.0% reading +5 digits)
100nF	0.1nF	

1uF	0.001uF	
10uF	0.01uF	
100uF	0.1uF	
1mF	0.001mF	± (4.0% reading +5 digits)
10mF	0.01mF	
100mF	0.1mF	± (5.0% reading +5 digits)

Over voltage protection: 600V DC or AC RMS

Frequency

Range	Resolution	Accuracy
10Hz	0.001Hz	± (1.0% reading +5 digits)
100Hz	0.01Hz	
1kHz	0.1Hz	
10kHz	1Hz	
100kHz	10Hz	
1MHz	100Hz	
10MHz	1kHz	

Minimum input voltage: 200mV (RMS)

Over voltage protection: 600V DC or AC RMS

Duty ratio

Range	Resolution	Accuracy
1%~99%	0.1%	± (3.0% reading +5 digits)

Minimum input voltage: 200mV (RMS)

Over voltage protection: 600V DC or AC RMS

AC current

Range	Resolution	Accuracy
600uA	0.1uA	$\pm(1.0\% \text{ reading} + 5 \text{ digits})$
6mA	1uA	$\pm(1.0\% \text{ reading} + 3 \text{ digits})$
60mA	10uA	
600mA	100uA	$\pm(1.2\% \text{ reading} + 3 \text{ digits})$
6A	1mA	$\pm(1.5\% \text{ reading} + 3 \text{ digits})$
10A	10mA	

Maximum input current of mA jack: 600mA (RMS)

Maximum input current of 10A jack: 10A (RMS)

Frequency range: 40Hz~1000Hz

DC current

Range	Resolution	Accuracy
600uA	0.1uA	$\pm(0.8\% \text{ reading} + 3 \text{ digits})$
6mA	1uA	
60mA	10uA	
600mA	100uA	$\pm(1.0\% \text{ reading} + 3 \text{ digits})$
6A	1mA	$\pm(1.2\% \text{ reading} + 3 \text{ digits})$
10A	10mA	

Maximum input current of mA jack: 600mA

Maximum input current of 10A jack: 10A

Instrument maintenance

This section provides basic maintenance information, including instructions for replacing fuse tubes and batteries. Unless you are an experienced maintenance **technician** and have relevant calibration, performance test and maintenance data, do not try to repair this instrument



Warning:

To prevent possible electric shock, fire or physical injury:

- **When the shell is opened, do not use the instrument for any measurement operation.**
- **Remove the input signal before cleaning the instrument.**
- **Designated replacement parts should be used. Please have the instrument repaired by an approved technician.**

General maintenance

Regularly use wet cloth and a small amount of detergent to clean the instrument shell. Do not use abrasive or chemical solvents.

Replacement of the battery and fuse tube

Warning:

- In order to avoid electric shock or physical injury caused by wrong readings, the battery should be replaced in time when the "" symbol appears on the instrument display screen.
- In order to ensure the safe operation and maintenance of the product, please take out the battery when the instrument is not used for a long time to avoid damaging the product by the battery leakage.
- Only fuses with specified amperage, fusing rating, voltage rating and fusing speed can be used.
- To avoid electric shock or physical injury, before opening the back cover to replace the battery, shut down the instrument and check to ensure that the probe has been disconnected from the measuring circuit.

Please replace the battery as the following steps:

1. Turn off the power supply of the instrument.
2. Disconnect the probe from the measured circuit.
3. Loosen the screws fixing the battery cover with a screwdriver and remove the battery cover.
4. Remove the battery and replace it with a new one. Pay attention to the positive and negative polarity of the battery.
5. Install the battery cover and tighten the screws.

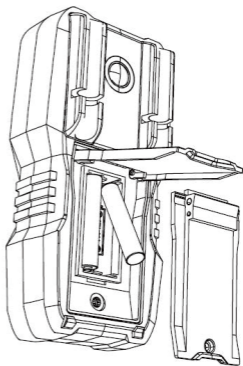

Please replace the battery as the following steps:

1. Turn off the power supply of the instrument.
2. Disconnect the probe from the measured circuit and remove the protective leather case.
3. Loosen the screws fixing the back cover with a screwdriver and remove the back cover.

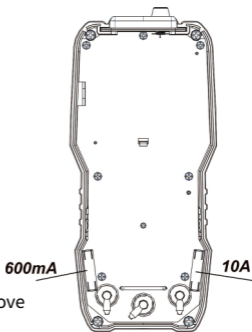

4. Remove the damaged fuse tube and replace it with a new one.
5. Install the back cover, tighten the screws, and install the leather cover

Attention:

600mA fuse tube: 600mA/600V;

10A fuse tube: 10A/600V;

**Warning**

The fuse tube should be replaced with the same specification and parameters, and it is strictly forbidden to use the fuse tube with different specifications and parameters, otherwise there will be a risk of damaging the instrument.